

# Circuito de Resultados **CAMPO FUTURO**

## 2024

Melhore a gestão de sua propriedade rural

**Curitiba (PR) | 📅 26 agosto**

**Atividades Agrícolas e Pecuárias**

Parceiro:

**SISTEMA FAEP**



Realização:



**Campo Futuro**

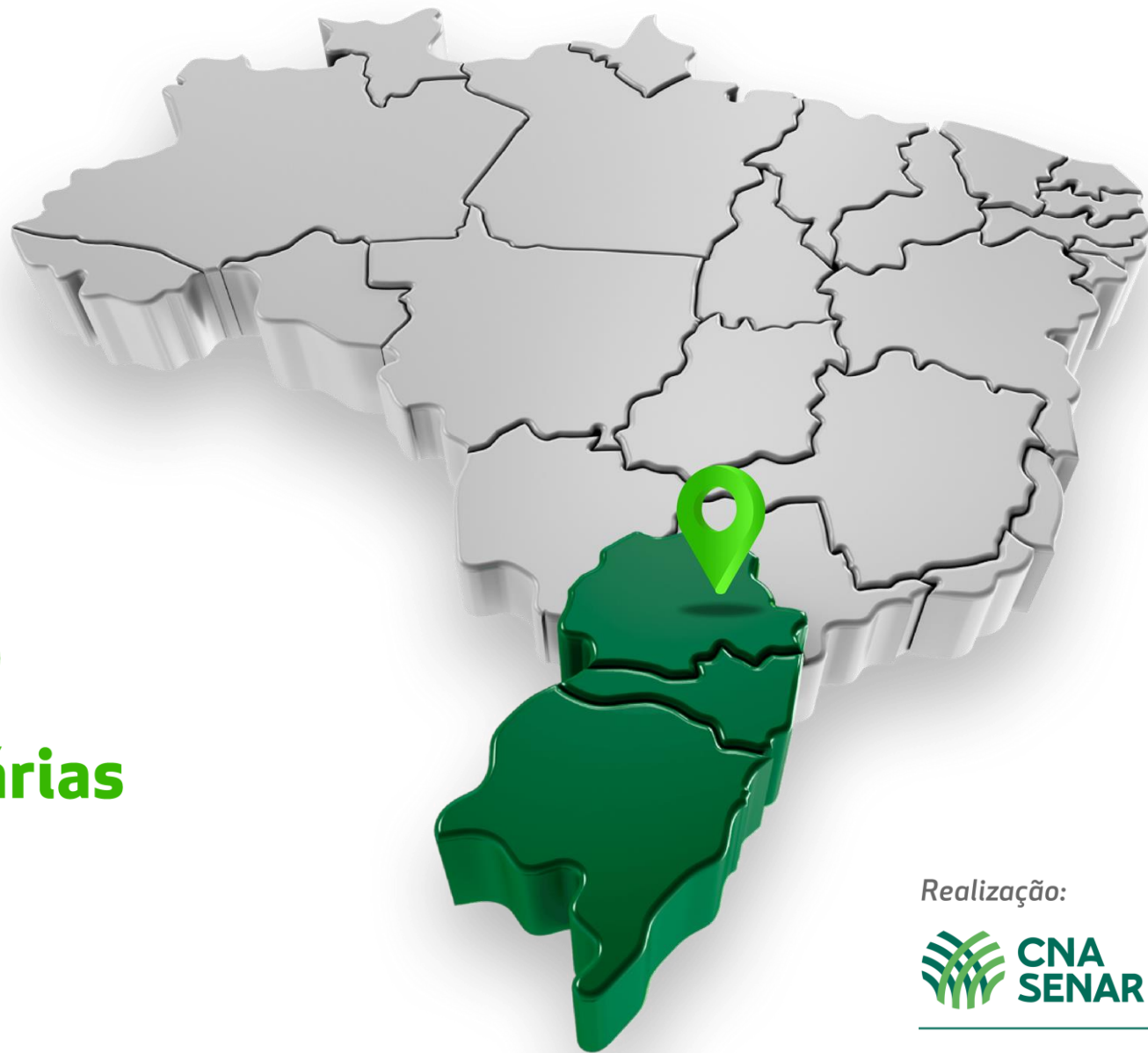

*Circuito de Resultados*  
**CAMPO FUTURO**

— 2024 —

*Melhore a gestão de sua propriedade rural*

**FERTILIZANTES**



# Uma inovação que salva vidas



Desde sua descoberta, os fertilizantes salvaram **mais vidas** que qualquer outra inovação criada pelo homem!

Fonte: <https://www.medigo.com/blog/infographics/lifesaving-innovations/>

[nutrientesparaavida.org.br](http://nutrientesparaavida.org.br)

Circuito de Resultados **CAMPO FUTURO** 2024

Melhore a gestão da sua propriedade rural



# Mean winter wheat grain yields (5-yr averages, 1843-2016)

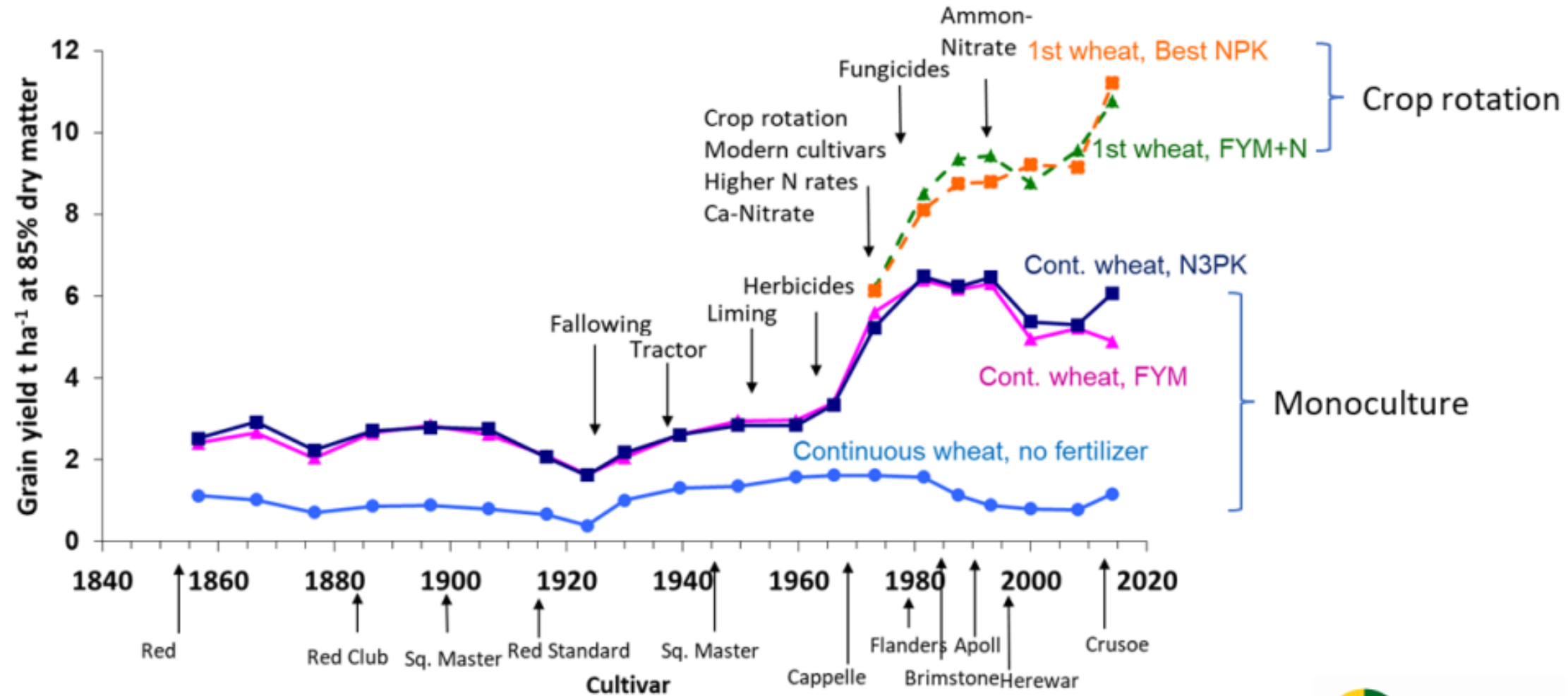

**Broadbalk Long-Term Experiment, Rothamsted, UK**



# MERCADO GLOBAL DE FERTILIZANTES:

Maiores consumidores de fertilizantes do mundo.

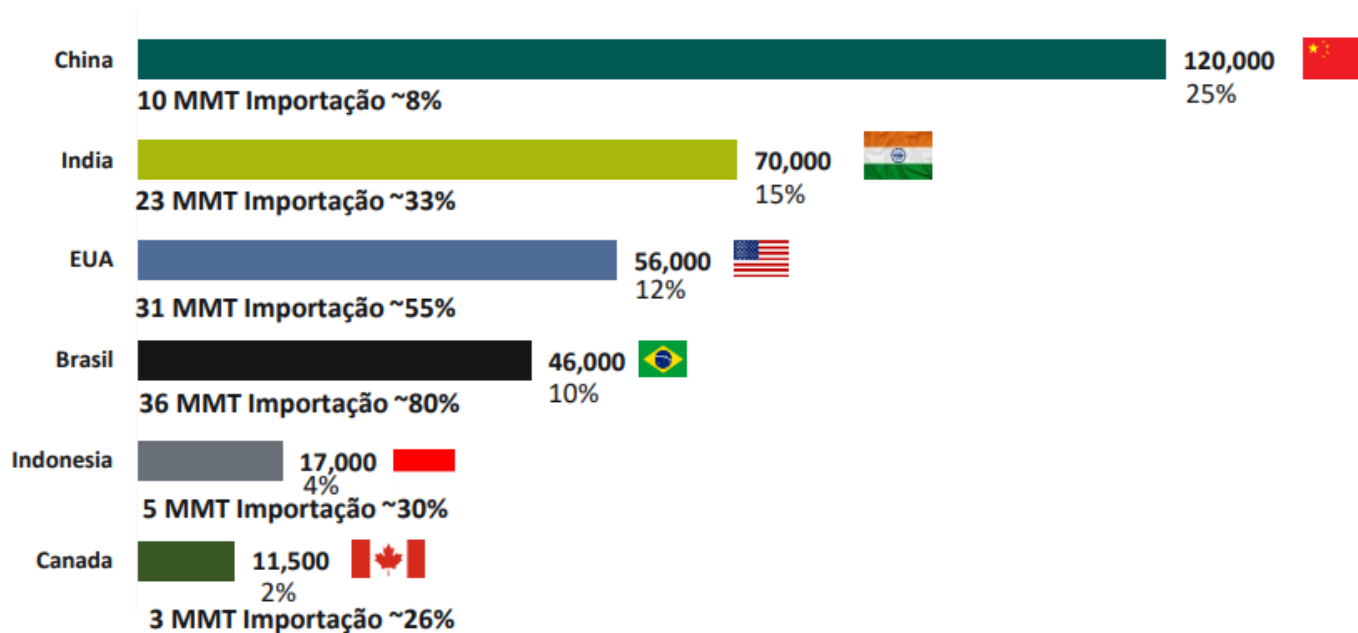

A China e a Índia são os principais países, representando mais de um terço da demanda global.

Fonte: IFA/GlobalFert



### PRINCIPAIS ORIGENS DE IMPORTAÇÃO DE UREIA

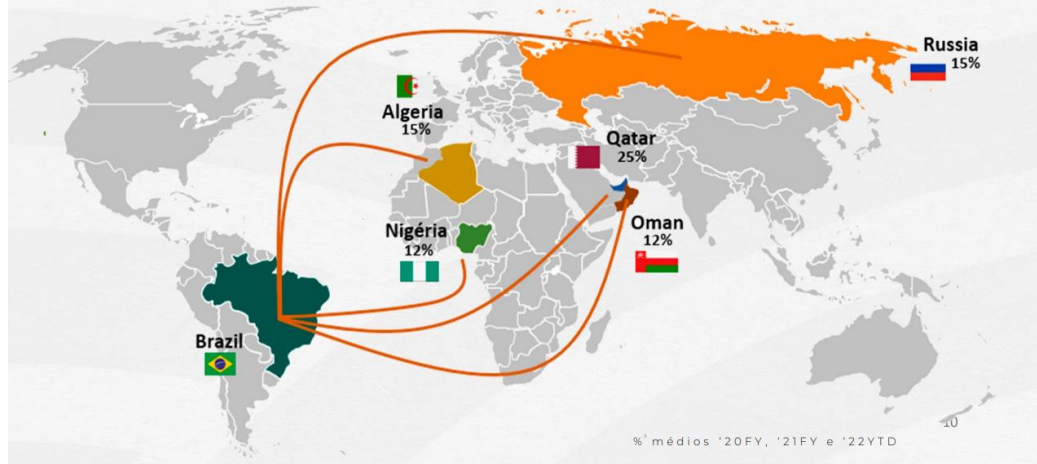

### PRINCIPAIS ORIGENS DE SULFATO

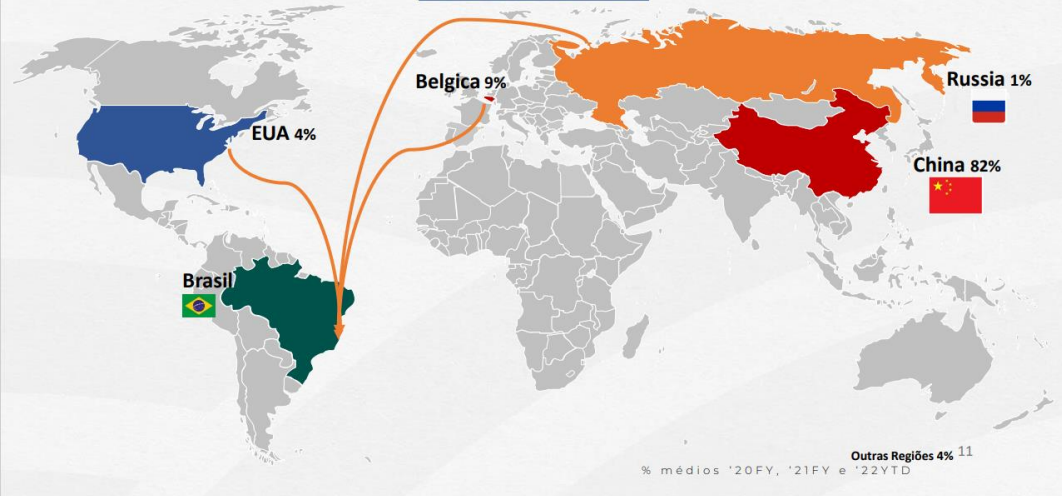

### PRINCIPAIS ORIGENS DE KCI

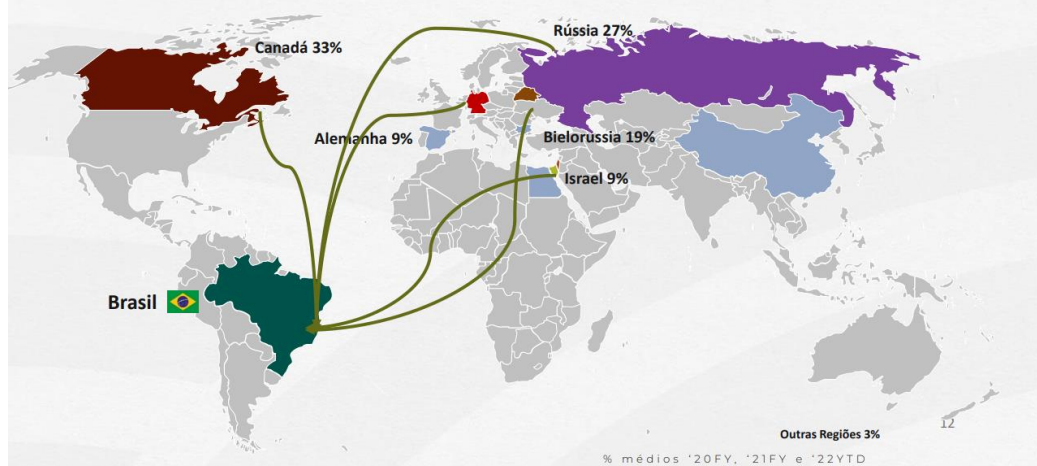

### PRINCIPAIS ORIGENS DE IMPORTAÇÃO (MAP/DAP/NPS)

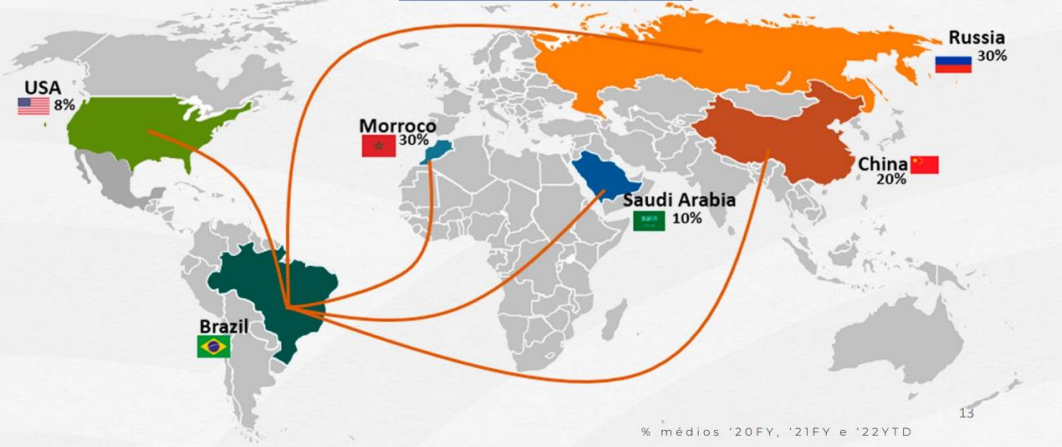

# EVOLUÇÃO DO MERCADO BRASILEIRO DE FERTILIZANTES

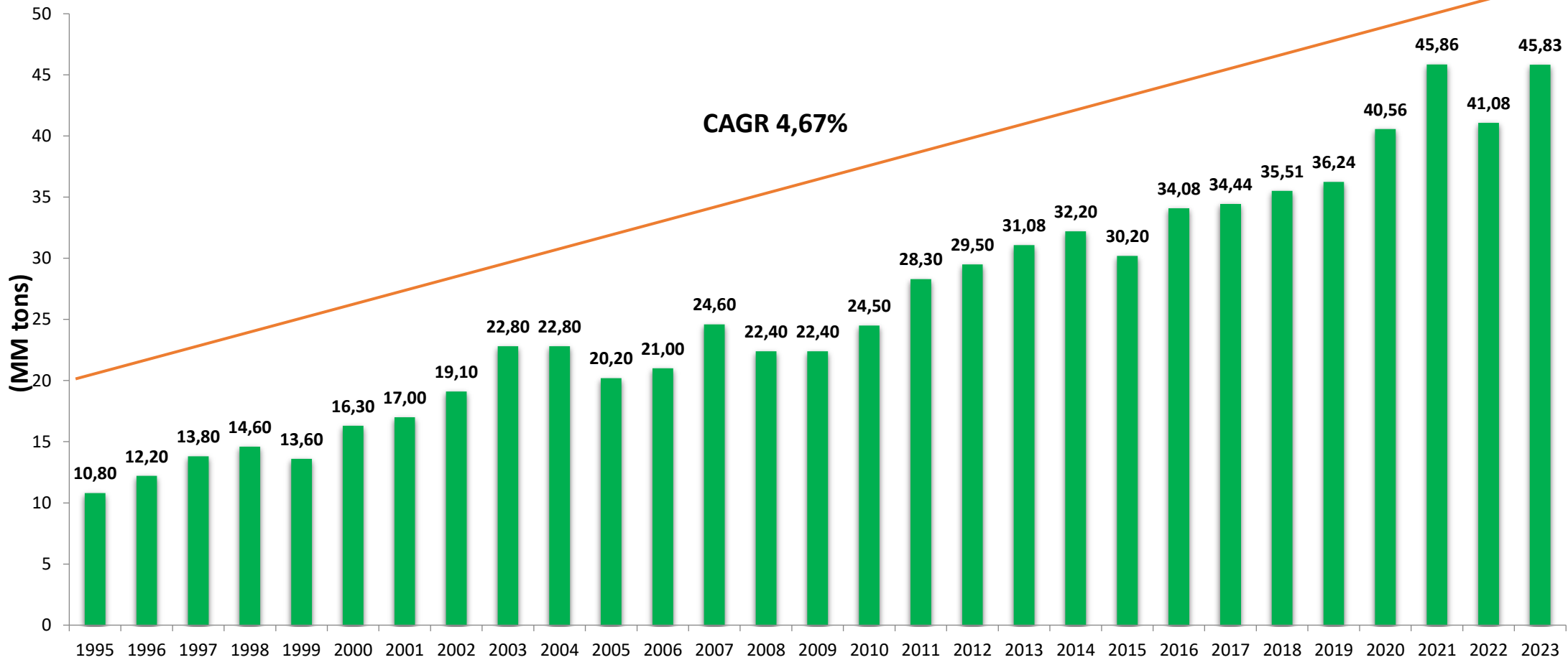

Maio23 – Maio24 -1,8%



Circuito de Resultados CAMPO FUTURO 2024

Melhore a gestão da sua propriedade rural



## Preço médio de importação de fertilizante pelo Brasil, em US\$ por kg

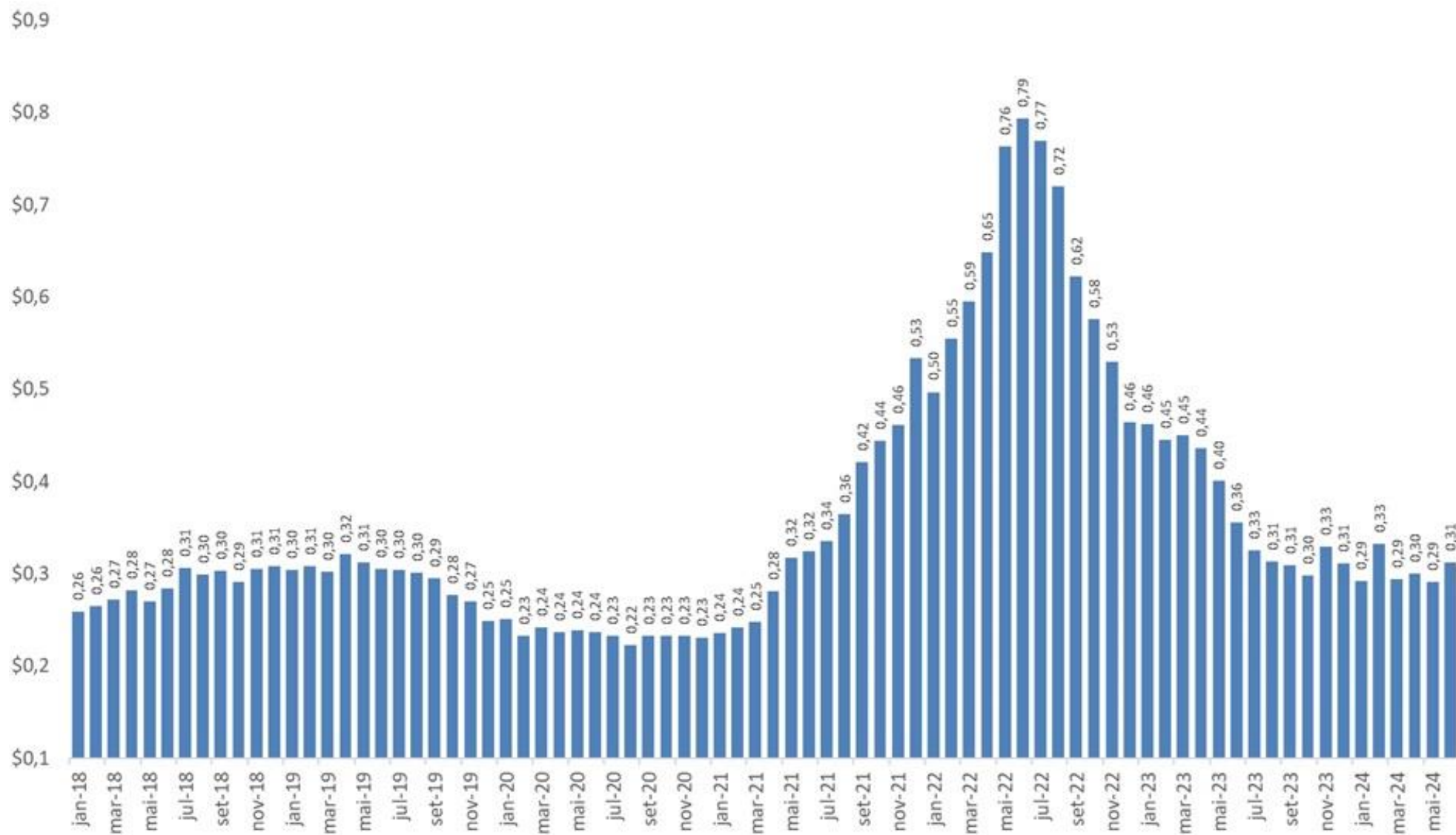

Circuito de Resultados **CAMPO FUTURO 2024**

Melhore a gestão da sua propriedade rural





# Preço médio de importação de fertilizante pelo Brasil, em US\$ por kg

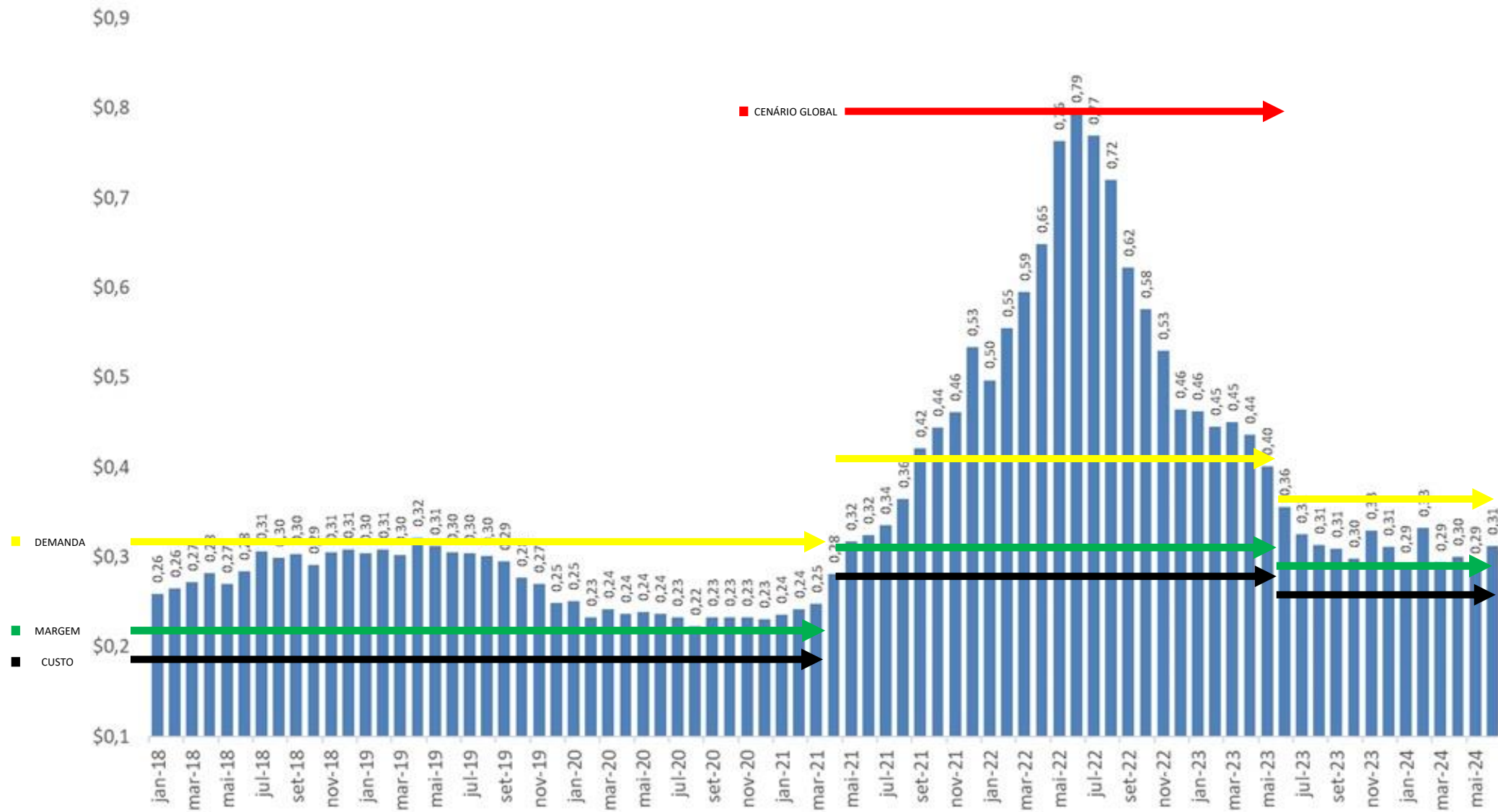

## Ureia Regional

■ Sorriso-MT ■ Rio Verde-GO ■ Cascavel - PR ■ Uberlândia - MG



## KCI REGIONAL

■ Sorriso-MT ■ Rio Verde-GO ■ Cascavel - PR ■ Uberlândia - MG



## KCI REGIONAL

■ Sorriso-MT ■ Rio Verde-GO ■ Cascavel - PR ■ Uberlândia - MG



## MAP REGIONAL

■ Sorriso-MT ■ Rio Verde-GO ■ Cascavel - PR ■ Uberlândia - MG



Preço Matérias-Primas				
Matéria Prima	CFR (\$/t)	Semana	FCA (\$/t)	FCA (R\$/t)
DAP	\$635	→ 0,0%	\$724	R\$ 4.015
MAP	\$635	→ 0,0%	\$724	R\$ 4.015
S.Triplo	\$515	→ 0,0%	\$604	R\$ 3.348
Ureia	\$347	↓ -1,4%	\$410	R\$ 2.273
KCl	\$293	↓ -1,7%	\$349	R\$ 1.937
Nit. Amônio	\$278	→ 0,0%	\$368	R\$ 2.041
S.Simples	\$235	→ 0,0%	\$290	R\$ 1.609
Sulf. Amônio	\$170	↓ -0,6%	\$236	R\$ 1.308

Obs: Os valores são referencias das últimas semanas, FOB Indústria Paranaguá

Fonte: AGRINVEST COMMODITIES

Circuito de Resultados **CAMPO FUTURO 2024**

Melhore a gestão da sua propriedade rural





N<sup>7</sup>

Nitrogen

# CENÁRIO NITROGÊNIO

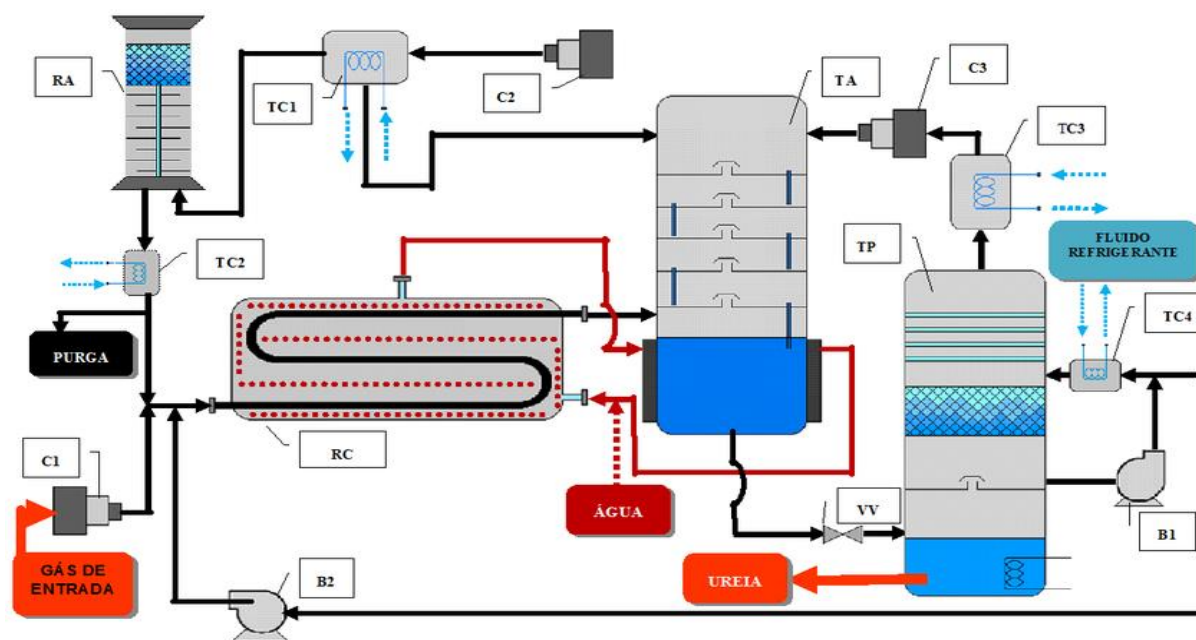

Circuito de Resultados **CAMPO FUTURO 2024**

Melhore a gestão da sua propriedade rural



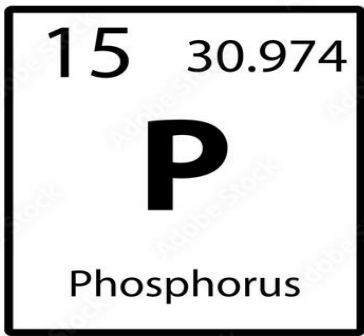

# CENÁRIO FÓSFORO



Circuito de Resultados **CAMPO FUTURO 2024**

Melhore a gestão da sua propriedade rural





19

**K**

Potassium  
39.098

# CENÁRIO POTÁSSIO



## Extração por Dissolução

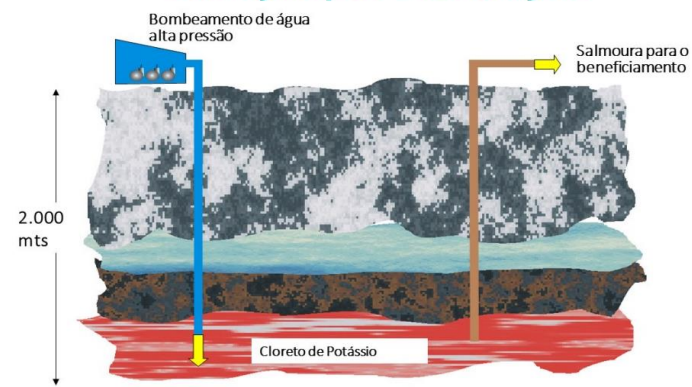

Circuito de Resultados **CAMPO FUTURO 2024**

Melhore a gestão da sua propriedade rural



- Mercado internacional coordena mercado nacional
- Delay de compra importação para disponível
- Em U\$ e U\$
- Dificuldade em dominar as variáveis que envolvem todo o cenário.





Circuito de Resultados **CAMPO FUTURO** 2024

Melhore a gestão da sua propriedade rural





Circuito de Resultados **CAMPO FUTURO** 2024

Melhore a gestão da sua propriedade rural







“Uso EFICIENTE do Fertilizante é a maior economia”

Circuito de Resultados **CAMPO FUTURO** 2024

Melhore a gestão da sua propriedade rural







# MUITO OBRIGADO!

JORGE A CHIAVINI MARTELLI



[jorge@nutrientes.ind.br](mailto:jorge@nutrientes.ind.br)



[www.nutrientes.ind.br](http://www.nutrientes.ind.br)